

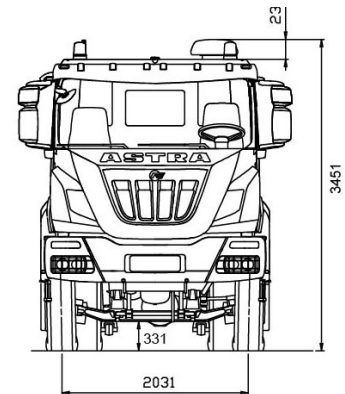
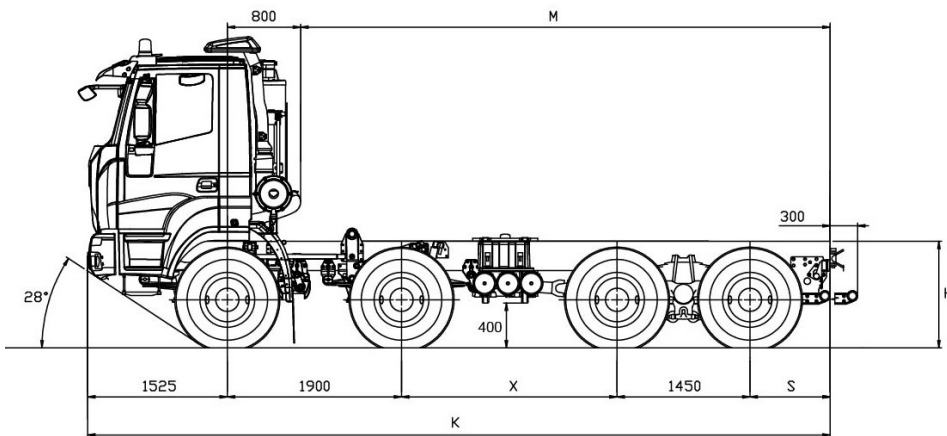

**chassis 8x4  
HD84.52**

**DIMENSIONS (MM)**

X	K	M max(*)	S	H		TURNING DIAMETER (wall to wall)
				unloaded	loaded	
4250	8425	6100	1200	1189	1129	19100
4500	8675	6350	1200	1189	1129	19900
4750	8925	6600	1200	1189	1129	20700
5000	9175	6850	1200	1189	1129	21500
5250	9425	7100	1200	1189	1129	22200
5500	9975	7650	1500	1189	1129	23000
6000	10475	8150	1500	1189	1129	24600

(\*) M max.: indicative value to be confirmed by bodybuilder.  
(Tyres 13R22.5)

**WEIGHTS (KG)**

X	Distribution net weight(*)			Max technical weight			
	Front axles	Rear axles	Net Weight	Front axles	Rear axles	Gross Vehicle Weight	Gross Combination Weight
4250	6865	4110	10975	16000 18000 (1)	32000	50000 (2)	104000
4500	6850	4150	11000				
4750	6835	4185	11020				
5000	6860	4260	11120				
5250	6855	4290	11145				
5500	6830	4355	11185				
6000	6820	4410	11230				

(\*) Net weight including driver with tanks filled to at least 90%, equipped with standard equipment according to the manufacturer's specifications and, if fitted, the mass of the bodywork, spare wheels and tool box.

(1) With tyres on front axles 385/65R22.5 or 325/95R24 and reinforced springs (OPT).

(2) With tyres 325/95R24 or max speed limited to 70 Km/h depending on pneus type and brand.

Higher speeds are allowed with load reductions subject to Astra technical office approval.



## ENGINES

CURSOR 13 turbo intercooler diesel injection/cycle with electronic unit injection pumps. 6 in-line cylinders. Single block head, four valves per cylinder, light alloy pistons. Total displacement: 12.882 cm<sup>3</sup>. Bore for stroke: 135 x 150 mm. Water cooling. Dry air filter with safety cartridge. Vertical muffler. Emissions according to Euro 5 regulation norms SCR (Selective Catalytic Reduction) system composed of catalytic muffler, AdBlue-tank, injection and control system.

Max.power(EEC) 382 KW (520 HP) @ 1900 rpm  
 Max.torque(EEC) 2400 Nm (245 kgm) @ 1000 - 1440 rpm  
 Turbine VGT(Variable Geometry Turbocharger)



## GEARBOX

Manual **ZF 16S2520TO** Ecosplit 4 technology gearbox with servoshift, 16 synchronised forward speeds + 2 reverse:  
**On request: ZF16S2320TD - ASTRONIC ZF16AS2630TO.**

		Speed [kph] calculated at maximum power rpm																	
		Gears / Gear ratios																	
Gearbox model	Rear axle ratio	1st	2nd	3rd	4th	5th	6th	7th	8th	9th	10th	11th	12th	13th	14th	15th	16th	rev. 1st	rev. 2nd
<b>16AS 2630 TO</b>		14.12	11.68	9.54	7.89	6.52	5.39	4.57	3.78	3.09	2.56	2.09	1.73	1.43	1.18	1	.83	13.07	10.81
	<b>4.227</b>	6.51	7.87	9.64	11.66	14.11	17.06	20.12	24.33	29.76	35.92	44.00	53.16	64.31	77.94	91.97*	110.80*	7.04	8.51
<b>16S 2520 TO</b>		13.8	11.54	9.49	7.93	6.53	5.46	4.57	3.82	3.02	2.53	2.08	1.74	1.43	1.2	1	.84	12.92	10.8
	<b>4.227</b>	6.66	7.97	9.69	11.60	14.08	16.84	20.12	24.07	30.45	36.35	44.21	52.85	64.31	76.64	91.97*	109.48*	7.12	8.52

(\*) Max limited speed 90 km/h. Other speeds available, subject to the Astra technical office approval.



## CLUTCH

Single dry plate, diameter 17". Pull type engagement with diaphragm spring. Hydro-pneumatic power steering engagement control, with driven disk wear recovery slave cylinder.

**On request:** Ceramic clutch 17".



## AXLES

**FRONT**  
Steering axle, hot moulding in high tensile steel. Wheel stud protection.

**REAR**  
Two drive axles in tandem. Double reduction: central with beveled pair, final in the wheel hubs by means of epicycloidal assembly. Torque distribution between the axles by means of a distributor fitted on the intermediate axle. Differential lockable from driver seat. Tandem assembled to the chassis by reaction rods with silentblocks.

**On request:** Rear-axle ratio 1:3,793; 1:4,229; 1:5,009; 1:5,558; 1:6,095; 1:6,588.



## SUSPENSIONS

**FRONT**  
1st and 2nd axle, parabolic springs, n° 3 leaves 26x90 mm, hydraulic shock absorbers.

Standard stabilizer bar on 1st axle.

**On request:**

Stabilizer bar on 2nd axle.

Reinforced parabolic springs, n° 4 leaves 26x90 mm.

Mandatory with 9t load 1st + 2nd axle.

**REAR**

Parabolic springs, swivelling on central pin: n° 4 leaves 40x100 mm, torque bars and stiffening brackets.

Standard stabilizer bar on 4th axle.

**On request:**

Stabilizer bar on 3rd axle.

Extra-reinforced conventional springs, n° 10 leaves 25x100 mm.



## CHASSIS

Special steel with high tensile strength limit, two flat and parallel side members (width 820 mm.), C section (320x90x10mm), cross members bolted to the frame. R.B.M. (Rail Bending Moment): 202.020 Nm (20.593 Kgm.). Steel front bumpers with headlamp protection grids, front maneuvering hook, rear underrun bar, rubber mud-guard 2nd axle, steel fuel tank capacity 300 litres.



## STEERING

ZF 8099 quadrilateral power steering on front axle wheels with variable ratio 1:22.2/1:26.2 with auxiliary cylinder. Circuit with main hydraulic pump on engine and emergency pump on gearbox. Steering rods with self-lubricating joints. Height and inclination pneumatic adjustable steering column.



## TYRES

**FRONT:** 13R22.5 156/150 G Single tubeless

**REAR:** 13R22.5 156/150 G Twin tubeless

Spare wheel on the chassis.

Other Possible combinations:

315/80 R22,5 156/150K

385/65 R22.5 160J (\*) + 315/80 R22,5 156/150K

325/95 R24 162/160K (\*)

(\*) Mandatory with 9 ton front axle load.

Other tyres available, subject to the Astra technical office approval.



## BRAKES

Front and rear "duo-duplex" self-adjusting wedge type brakes with automatic play take-up. Total net braking surface 12.368 cm<sup>2</sup>. ABS + EBL system.

**Service brake:** Pedal controlled air brake, acting on all wheels. Solo vehicles: two independent circuits, one for 1st and 2nd axle: one for 3rd and 4th axle. Towing vehicles: three independent circuits, one for 1st and 2nd axle, one for 3rd and 4th axle and another for the trailer.

**Emergency brake:** Incorporated in service brake.

**Parking brake:** Mechanical spring-type with pneumatic control acting on 3rd and 4th axle wheels.

**IVECO TURBO BRAKE:** braking power 255 kW (347 HP)

**On request:**

1st axle immobiliser system.

OFF/ROAD button for excluding ABS for speed 15 kph.

Front and rear "simplex" self-adjusting brakes system without ABS.



## ELECTRICAL SYSTEM

Voltage: 24 V

Alternator generator 90 A - 28 V (2520 W).

Accumulators: 2 in series, 180 Ah.

Starter motor 24 V 5,5 kW.

Mechanically controlled electrical circuit breaker.



## CAB

Standard white short cab built in galvanized pressed steel with hydraulic tilting up to 60°. Cab suspension with 4 helicoidal springs with coaxial shock absorbers and integrated dampers, anti-roll bar and end-of-stroke pads. Tinted electric door windows. Mechanical rear view mirrors, wide angle mirrors and front view mirror. Internal panels completely washable and fireproof. Compressed air quick coupling for cab cleaning. 4-speed ventilation and heating system with air recirculation system. Air suspended 3-way adjustable driver seat with seat belts. Mechanical passenger seat with seat belts.